

Fieldpiece

Carbon Monoxide Detector

OPERATOR'S MANUAL

Model SCM4

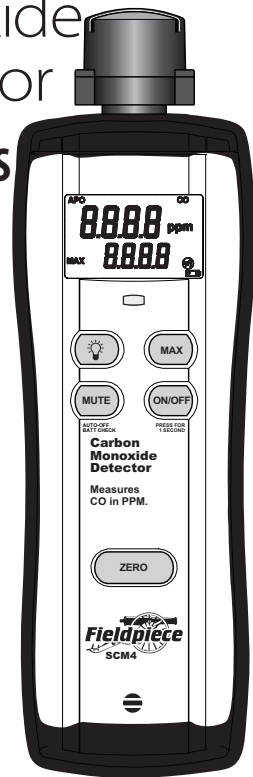

Quick Start

1. Install 9V battery located in the battery compartment.
2. Press ON/OFF for 1 second to power on the SCM4 in a nominal CO environment such as outdoors.
Note: 10 second warm up ensues.
3. If necessary, press ZERO while outdoors to set the ambient CO ppm.
4. Carbon monoxide (CO) above nominal levels will be displayed in parts per million (ppm.)
5. Press ON/OFF for 1 second to power off.

Certifications



RCM



CE



WEEE

RoHS Compliant

Description

The SCM4 standalone carbon monoxide detector measures carbon monoxide in parts per million (ppm.) It is intended to measure levels of CO in still, ambient air. The most practical application of the SCM4 is to determine if the indoor CO levels are higher than outdoor levels and to determine the source. In many cases, it can help locate a source of CO.

The SCM4 uses a fast reacting, electrochemical sensor that does not consume chemicals and can easily be replaced in the field if needed. Sensor life is primarily determined by the type of exposure.

Precautions

1. Do not measure gas engine exhaust or other high CO or highly contaminated gases. High levels of CO and other contaminants can ruin the sensor and be a health hazard.
2. Do not take readings directly in stream of air at register or in a flue.
3. Allow enough time for SCM4 to reach ambient temperature and %RH.

WARNING

Extended exposure to even relatively low carbon monoxide concentrations can be hazardous to human health. Evacuate areas of significant CO concentration immediately. See the CO Exposure Effects section of this manual.

CAUTION

Do not take measurements directly at a tailpipe, or at a flue. See "Precautions."
Do not rely solely on a carbon monoxide measurement to determine if a heat exchanger is bad. See "CO Detectors and Cracked Heat Exchangers" section.
The majority of toxic gas sensors contain sulphuric acid electrolyte and the chemical hazard is mainly related to the corrosive nature of this compound. These sensors also contain platinum, ruthenium, gold, silver, carbon some of which are toxic.
Any skin or eye contact with the contents of these sensors should be washed immediately with copious amount of water. Obtain medical advice.
Electrochemical gas sensors are sealed units containing an aqueous electrolyte and a combination of other substances as detailed above. Provided these sensors are used only for their intended application they do not represent a chemical hazard.
The sensors must not be exposed to temperatures outside the range -50°C to 60°C. Toxic gas sensors should not be exposed to organic vapours which may cause physical damage to the body of the sensor, for example 1, 2 dichloroethane.
Should any sensor be so severely damaged that leakage of the contents occurs then the following procedures should be adopted.
a. Avoid skin contact with any liquid or internal component through use of protective gloves.
b. Disconnect sensor if it is attached to any equipment.
c. Use copious amounts of clean water to wash away any spilt liquid. This is particularly important in equipment where the sensor involved contains sulfuric acid or phosphoric acid because of the corrosive nature of these electrolytes.

Display

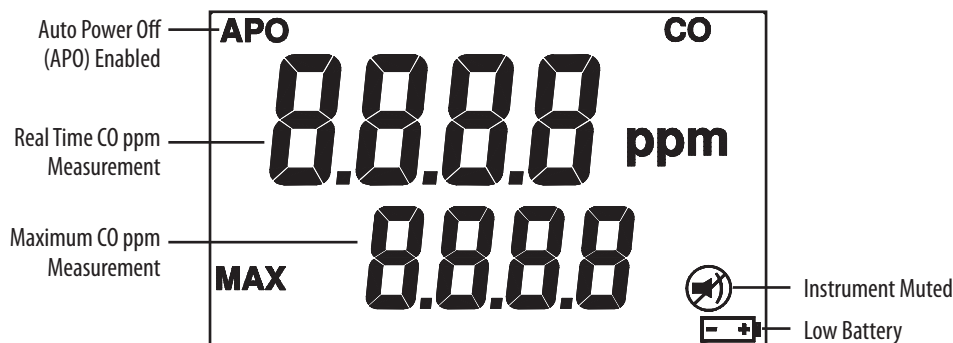

Controls



Hold for one second to toggle power.



Mute the beep. Hold for one second to check % battery remaining. (Hold while powering ON to disable APO.)



Cancel out any ambient nominal CO. (See Zero Set.)



Show maximum measurement.



Toggle backlight on display.

How to Use

"Walk Around" Test

The SCM4 responds almost instantly to changes in CO levels in the air. If you see a difference in CO levels from outside to inside, you need to find the source of the CO. Walk around and watch the display.

By constantly going towards the area of higher concentration, you can determine the source of the CO.

Persistent sources of CO, such as malfunctioning combustion equipment in occupied spaces, must be serviced immediately. These can be life threatening.

When searching for sources of CO, make sure that you never put yourself or anyone else in danger of excessive exposure to CO. Overexposure to CO can have long-term health effects and can be fatal.

Zero Set

As needed, set the reading to zero in a known zero CO atmosphere and in a temperature similar to the sample air to be tested. Zero only when ambient air is within specifications and probe is in equilibrium (temperature and relative humidity) with ambient.

To zero, hold the ZERO button for one second or until "ZERO" is displayed. (Note: For safety reasons the SCM4 will not zero if reading is above 5ppm.)

Specifications

Sensor Type: Electrochemical (specific to CO)

Sensor Calibration:

Factory calibrated @ 17ppm CO and 200ppm CO

Range:

0 to 1000 ppm; 0 to 2000 ppm (less than 5 minute exposure time)

Initial Accuracy: @ 73°F±9°F, <75% R.H.

0-15ppm ±5% reading ±1 ppm after zeroing

16-35ppm ±5% reading ±2 ppm after zeroing

36-1000ppm ±5% reading ±5ppm after zeroing

Long Term Drift:

less than 5% per year (depending on use)

CO Air Sample Temperature Range:

32 to 105°F

Operating Environment:

32 to 122°F (0 to 50°C);

15 to 90% R.H., non-condensing

Storage Environment: 32 to 68°F (0 to 20°C) at

<80% R.H. with battery removed from meter.

Battery: 9V

Battery Life: 150 hours typical alkaline

Auto Power Off: After 15 minutes

CO Detectors & Cracked Heat Exchangers

A CO detector can't tell you if a heat exchanger is good. A CO detector can indicate that a heat exchanger may be cracked only if all of the following conditions occur simultaneously:

1. The flame must generate high concentrations of CO (lack of oxygen, excess fuel, high temp).
2. Enough exhaust gases must be emitted from the heat exchanger crack.
3. The exhaust gases from the crack must not be diluted too much before coming in contact with the sensor. A cracked heat exchanger may leak CO in a small stream. You may measure high concentrations at one point but low concentrations only an inch away.
4. The heat exchanger must be the only possible source for the CO detected.

CO Exposure Effects

9 ppm	Minimal. Max allowable concentration for eight hours (EPA and ASHRAE).
35 ppm	Max for continuous exposure for one hour (EPA and ASHRAE).
50 ppm	Max for eight hours (OSHA).
100 ppm	Trips installed CO detectors. UL2034 specifies a max exposure of 100 min.
200ppm	In two to three hours: slight headache, tiredness, dizziness, nausea. UL2034 specifies a max exposure of 35 min.
400 ppm	In one or two hours: frontal headaches. In three hours: life threatening. UL2034 specifies a max exposure of 15 minutes.
800 ppm	In forty five minutes: dizziness, nausea, and convulsions.
800 ppm	In two to three hours: death.
1600 ppm	In one hour: death.
6400 ppm	In fifteen minutes: death.
12800 ppm	In three minutes: death.

Note: Effects can vary significantly depending on age, sex, weight, and overall health.

Maintenance

Clean the exterior with a dry cloth. Do not use liquid.

Battery Replacement

When the meter displays  the battery should be replaced. Turn your SCM4 off and replace the 9V battery.

Check Your Sensor: Coffee Cup CO Test

To demonstrate that your CO sensor works, turn a ceramic coffee cup upside down and slide it over the edge of a counter (or desk) to expose about a third of the mouth of the cup. Burn a cigarette lighter inside the exposed mouth of the cup. Burn a cigarette lighter inside the exposed mouth of the cup. When the flame starts to flicker, you've burned up most of the oxygen in the cup creating carbon dioxide and now you're starting to produce carbon monoxide. Bring the flame in and out of the mouth of the coffee cup to just keep the flame alive. The longer you keep

the flame flickering, the more CO you produce. After 10 seconds of flickering, extinguish the flame and put the CO head in the mouth of the cup. You should see readings in the 100s. Take it out if it approaches 1000PPM.

CO Sensor Replacement

The SCM4 uses a carbon monoxide smart sensor. If you are seeing erratic CO readings or no readings in a known CO environment, you likely need to replace the sensor.

1. Obtain replacement sensor model RCM4 from your local distributor.
2. Remove sensor cap by removing the 4 screws.
3. Directly pull out old sensor.
4. Hold the new sensor by the sides. While holding the sensor on the sides; press down to secure the new sensor. Do not press the new sensor from the top.
5. If the sensor is incorrectly installed, "CO Err" will be displayed and the meter will automatically shut down after 5 seconds.

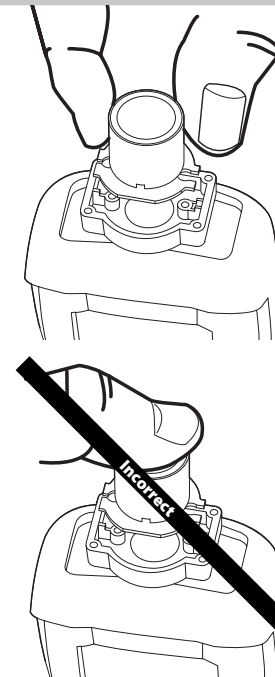
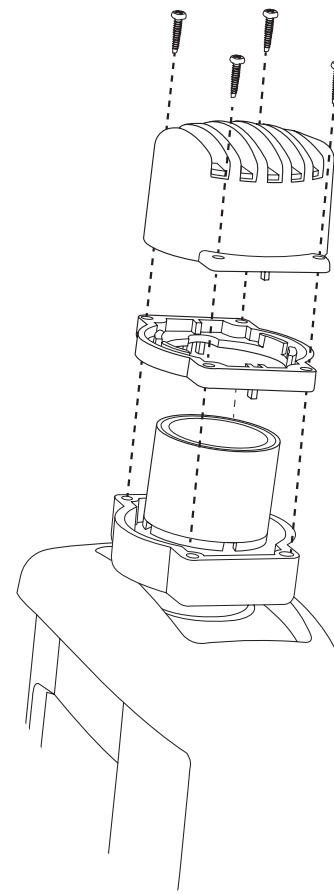

Sensor Disposal

The RCM4 replacement carbon monoxide smart sensor contains sulfuric as well as precious metals. The sensor should be recycled properly through a local electronic waste center.

Limited Warranty

This meter is warranted against defects in material or workmanship for one year from date of purchase. Fieldpiece will replace or repair the defective unit, at its option, subject to verification of the defect.

This warranty does not apply to defects resulting from abuse, neglect, accident, unauthorized repair, alteration, or unreasonable use of the instrument.

Any implied warranties arising from the sale of a Fieldpiece product, including but not limited to implied warranties of merchantability and fitness for a particular purpose, are limited to the above. Fieldpiece shall not be liable for loss of use of the instrument or other incidental or consequential damages, expenses, or economic loss, or for any claim of such damage, expenses, or economic loss.

State laws vary. The above limitations or exclusions may not apply to you.

For Service

In the USA, call Fieldpiece Instruments for one-price-fix-all out of warranty service pricing. Send check or money order for the amount quoted. Send the meter freight prepaid to Fieldpiece Instruments. Send proof of date and location of purchase for in-warranty service. The meter will be repaired or replaced, at the option of Fieldpiece, and returned via least cost transportation. Outside of the USA, please visit www.fieldpiece.com for service contact information.



www.fieldpiece.com

©Fieldpiece Instruments, Inc 2018; v10

More from Fieldpiece

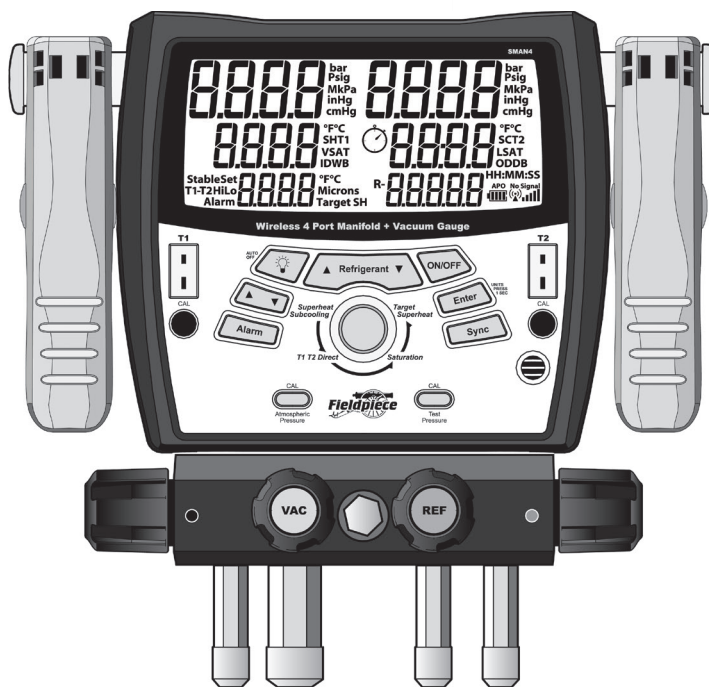

Digital Refrigerant Manifolds



Combustion Check with AutoPump

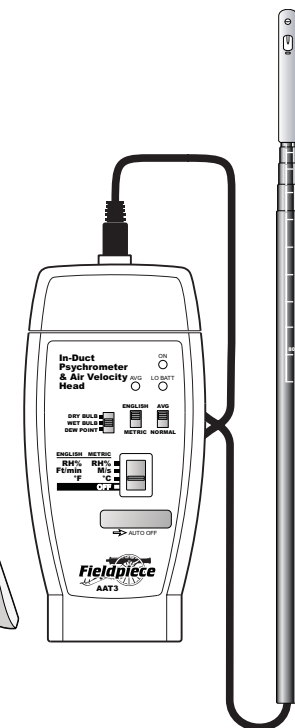

Accessory Heads

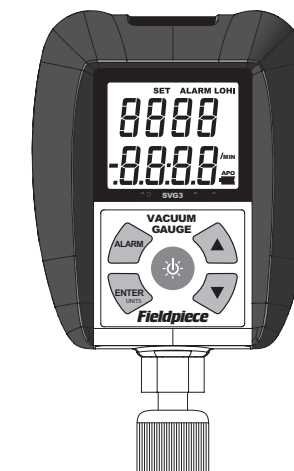
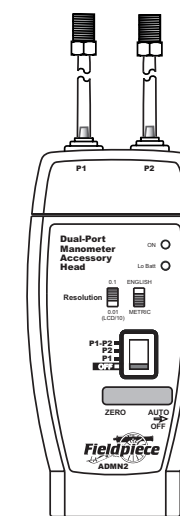

Vacuum Gauge