

Fieldpiece

Combustion Check with AutoPump

OPERATOR'S MANUAL

Model SOX3

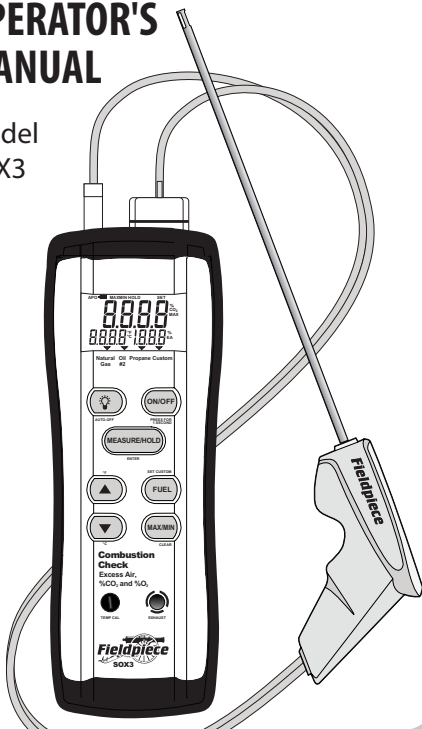

Quick Start

1. Press ON/OFF to power on the SOX3.
2. A 30 second warm up ensues.
3. Press FUEL to cycle through fuel types.
4. Insert the barrel of the SOX3 into flue.
5. Press MEASURE/HOLD to begin taking measurements.
6. Use the up arrow button to toggle the upper display between %O₂ and %CO₂.
7. Use the down arrow button to toggle the lower (right) display between %EA and % (Efficiency of condensing or non-condensing).
8. Make sure all holes in the flue are sealed after testing is finished.

Description

The SOX3 is a portable hand held automated combustion check designed for the HVACR technician. The SOX3 provides all the essential measurements for checking and tuning combustion equipment.

Measure flue temperature and %O₂ directly to view the calculated %CO₂, %Excess Air (%EA) and %Efficiency (%) for condensing or non-condensing equipment.

The ergonomic handle and 8ft hose make for easy flue gas measurements. Use the magnetic strap and the barrel lock to go entirely hands free.

With three common fuel types as well as a custom fuel input the SOX3 allows you to check %O₂, %CO₂, %EA and % (efficiency) on any combustion equipment you may encounter.

Keep your SOX3 up and running longer with the field calibratable thermocouple and replaceable oxygen sensor.

Display

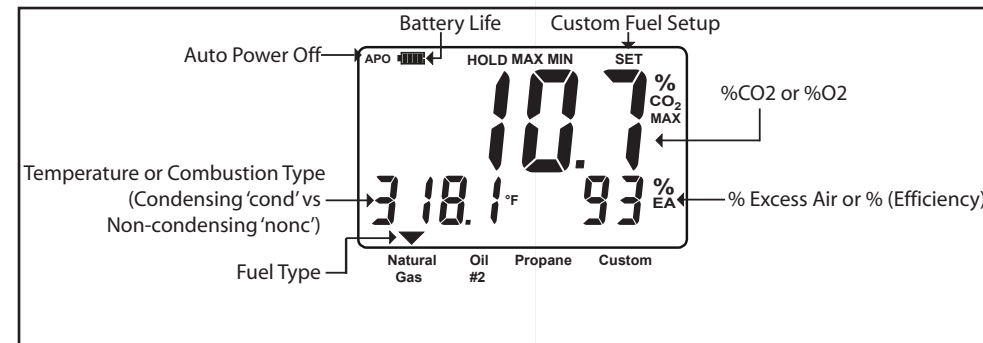

Controls

- ON/OFF** Hold for one second to toggle power.
- Lightbulb icon** Toggle backlight on display. (Hold while powering on the SOX3 to disable the meter's APO.)
- MEASURE/HOLD** Toggle between MEASURE mode (pump on, live readings) and HOLD mode (pump off, frozen readings).
- FUEL** Cycle through fuel types. Fuel indication arrow moves along lower display. (Hold for one second to enter Custom Fuel setup.)
- Up Arrow** (UP) Toggle between %O₂ and %CO₂. (Down) Toggle between %EA and %.
- Down Arrow** Use during Custom Fuel setup to adjust max %CO₂. (Hold respective arrow button while powering on to change temperature units to °F or °C.)
- MAX/MIN** Press to cycle through maximum, minimum, and real-time measurements. (Hold for one second to clear saved values and continue measuring.)

Certifications

- C-Tick (N22675)
- CE
- WEEE
- RoHS Compliant

⚠ WARNINGS

Combustion equipment is extremely hot. Never touch the SOX3 without knowing it is cool to the touch.

Exhaust may be hot. Do not put your skin directly in front of exhaust port.

How to Use

Pre-Testing

1. Power on the SOX3 and allow the unit to warm up for 30 seconds.
2. Calibrate temperature if needed (see Field Temp Calibration).
3. Check that SOX3 water and particle filters are dry and properly sealed.
4. Thoroughly inspect combustion equipment for damage.
5. Identify the fuel being combusted and use the FUEL button on the SOX3 to select that fuel. For fuel other than Natural Gas, Oil #2, or Propane see Custom Fuel setup.
6. Identify the flue and locate service port for taking flue measurements or, if necessary, drill a hole using a 1/2" bit (12.7mm) within 18" of the breach.
7. Once your combustion equipment has passed all of your preliminary and visual inspections, turn on the equipment to be tested.

Testing

1. Identify manufacturer's specifications for % efficiency, %EA (% Excess Air), %CO₂, or %O₂ in the flue. If manufacturer's specs are not available see Table 2 (on back).

2. Once combustion equipment has stabilized, insert rifle into flue gas at service port or drilled hole.

Note: Combustion samples should be taken before dilution air enters the system, before components like draft hoods and barometric dampers. Testing at least 6" upstream of the breach is the typical location for most equipment. As a general rule, the sample hole should be more than twice the flue diameter away from any elbows.

3. Press MEASURE/HOLD to start the internal pump and begin taking fuel measurements.
4. Toggle between %CO₂ and %O₂ with the up arrow button. Toggle between %EA and efficiency with the down arrow button.

Note: Efficiency calculations displayed toggle through % efficiency of condensing "cond" and non-condensing "nonc" equipment. The condensing % efficiency uses the high heating value (HHV) and the non-condensing % efficiency uses the low heating value (LHV) of the fuel type selected. Identify what equipment you are working on to decide which % efficiency calculation to use.

Note: The correct fuel type must be selected to properly display calculated values. Efficiency will not be calculated when using the custom fuel setting.

5. Wait for readings to stabilize, this can take a couple minutes.
6. Press the **MAX/MIN** button to cycle through maximum, minimum, and real-time values. (Hold MAX/MIN to clear saved values.)
7. Once stabilized, press MEASURE/HOLD to hold measurements and stop the pump.

8. Make necessary adjustments to bring the equipment within manufacturer's specifications.
9. Retest.

Post-Testing

1. Remove the rifle from the flue and allow time for the barrel to cool.
2. Plug any holes you may have put into the flue, with heat resistant silicone or comparable plug.
3. Power the meter off. The internal pump will run for a short time to purge the meter before completely shutting off.
4. Open and empty water trap before storing SOX3 in its case.

Custom Fuel Setup

The SOX3 can be setup to work with various fuel types. In order to enter a custom fuel, follow the steps below.

1. Hold the FUEL button, for one second until "SET" starts blinking in the upper right corner of the display and

- the units read "% CO₂ MAX"
2. Use the Arrow buttons to select the appropriate CO₂ MAX for the fuel you are working with.

Note: CO₂ Max is the theoretical maximum percentage of CO₂ produced when a fuel goes through complete combustion. Table 1 shows CO₂ max values for some more common fuel types.

3. Once you have selected the appropriate CO₂ max press the MEASURE/HOLD button to lock in this value and return the Hold display.
4. The fuel indication arrow on the display will automatically be moved to your newly entered custom fuel.

%CO ₂ Max values	
Fuel Oil #5	16.3
Kerosene	15.12
Bagasse	20.3
Dry Wood	20

%CO ₂ Max values	
Coal Anthracite	19.9
Coal Bituminous	18.5
Wood Pellets	20.1

Table 1

Field Temp Calibration

To calibrate the temperature sensor, turn the Temp-Cal pot while measuring a known temperature. Ice water is very close to 32°F (0°C) and is readily available.

1. Stabilize a large cup of ice water.
2. Disconnect water trap in order to cut off suction to the barrel. This will prevent sucking up water.
3. Plug in the k-type thermocouple and then immerse the barrel tip of the SOX3 into the ice water.
4. Press the Measure/hold button and read temperature on the lower left display.
5. For optimum accuracy, adjust the calibration pot to read 32°F or 0°C, depending on the scale selected.

Typical Recommended Flue Gas Measurements

Atmospheric Fan Assisted Natural Gas or LPG	
Oxygen (O ₂)	6 to 9%
Stack Temperature	325 to 500°F
Condensing Natural Gas or LPG	
Oxygen (O ₂)	6 to 9%
Stack Temperature	90 to 140°F
Natural Gas/LPG Power Burners	
Oxygen (O ₂)	3 to 6%
Stack Temperature	275 to 500°F
Fuel Oil Flame Retention Power Burners	
Oxygen (O ₂)	3 to 7%
Stack Temperature	325 to 500°F
Fuel Oil Non-Flame Retention Power Burners	
Oxygen (O ₂)	6 to 9%
Stack Temperature	400 to 600°F
Condensing Oil	
Oxygen (O ₂)	3 to 7%
Stack Temperature	90 to 140°F

Table 2.

Specifications

Sensor Type: Highly accurate oxygen sensor.
Operating environment: 32 to 122°F (0 to 50°C) at <75% R.H.
Storage environment: -4 to 140°F (-20 to 60°C) at <80% R.H. with battery removed from meter.
Temperature Coefficient: 0.1 times the applicable accuracy per ° from 32°F to 64°F and 82°F to 122°F (0 to 18°C and 28 to 50°C)
Battery: 9V.
Battery Life: 28 hours typical alkaline.
Auto Power off: After 15 minutes.
Accuracy: Stated accuracy at 23°C±5°C, <75% R.H.
Dimensions: 45.0mm(H) x 69.8mm(W) x 211.7mm(D).
Weight: approx. 579.7g with battery.
Display: 4 digit liquid crystal display(LCD) with maximum reading of 9999.
Low battery indication: The  is displayed when the voltage drops below the operating level.

TEMPERATURE

Range: -58°F to 1000°F (-50°C to 538°C)
Resolution: 0.1°
Accuracy: ±[0.6%+3°F(1.7°C)]after field calibration.
Sensor Type: Rod K-type thermocouple.
Range: -50°F to 900°F (continuous operation range) up to 1000°F (single exposure use)
Accuracy: (±4°F) on -50°F to 545°F (±0.75%) on 545°F to 1000°F
Oxygen
Oxygen Range: 0 to 25%
Accuracy: ±0.3%O₂ (Calibrated at 72°F, 20.9%O₂)
Max Overload: 30% Oxygen
Operational temp range: -4°F to 122°F
Response time: Under 2 minutes.

Maintenance

Clean the exterior with a dry cloth. Do not use liquid.
 Check filter before each use. If the filter looks dirty, wet or has not been changed for an extended period of use, replace with new filter.
 It is good practice to empty the water trap after every use. This helps prevent water build up that may damage the sensor or freeze within the hose during storage.

Battery Replacement

When the meter displays  the battery should be replaced. Turn your SOX3 off and replace with 9V battery.

O₂ Sensor Replacement

The SOX3 uses an oxygen smart sensor. The sensor should be replaced when incorrect oxygen levels in ambient air are displayed.
 1. Remove sensor cap by twisting CCW slightly and then pulling.
 2. Pull out old sensor.
 3. Align plug of new sensor and carefully press into place. Display will show "Err1" if sensor is not installed properly or damaged.
 To obtain an SOX3 replacement oxygen sensor (model# RS02) contact your local distributor.

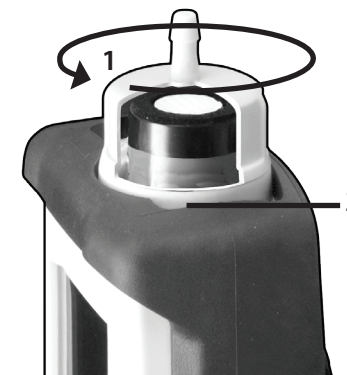

Limited Warranty

This meter is warranted against defects in material or workmanship for one year from date of purchase. Fieldpiece will replace or repair the defective unit, at its option, subject to verification of the defect.
 This warranty does not apply to defects resulting from abuse, neglect, accident, unauthorized repair, alteration, or unreasonable use of the instrument.
 Any implied warranties arising from the sale of a Fieldpiece product, including but not limited to implied warranties of merchantability and fitness for a particular purpose, are limited to the above. Fieldpiece shall not be liable for loss of use of the instrument or other incidental or consequential damages, expenses, or economic loss, or for any claim of such damage, expenses, or economic loss.
 State laws vary. The above limitations or exclusions may not apply to you.

Combustion Basics

Combustion is the rapid oxidation of fuel. Oxygen from air (20.9% oxygen & 79.1% nitrogen) is used to burn fuel which produces heat. The appliances installed and serviced by technicians rely on clean efficient flames to produce the energy needed to heat homes, water, etc. Combustion testing is necessary to maximize the efficiency of the combustion systems and to minimize the harmful emissions produced such as carbon monoxide and carbon dioxide. Proper tuning of the combustion process by combustion testing reduces the production of harmful carbon monoxide and decreases the amount of fuel burned due to increase in efficiency.

Combustion efficiency can typically be increased by creating a more balanced air to fuel ratio. The ratio of air to fuel determines how much CO₂ is produced and how efficient the flame is.

Tuning the O₂, CO₂ excess air, stack temperature, and temperature rise to match the appliance manufacturers specifications will increase the efficiency and help to maximize the performance and life expectancy of the equipment.

A properly tuned natural gas appliance will have between 6-9 O₂% in the flue while an oil appliance will have 3-7 O₂%.

Adjustments to the combustion process ensures that the highest combustion efficiency is safely achieved, thereby reducing the overall amount of fuel used in producing the energy needed. It is still necessary to test and adjust the appliance to the manufacturers' specification for airflow in the duct system, temperature rise across the heat exchanger and anything else that may need testing. Testing and balancing appliances to meet manufacturers' specifications helps to ensure maximum system efficiency and equipment longevity.

Combustion testing does not take into account start up losses, standby losses, cabinet/boiler body losses, or distribution losses in ducts or piping.

The diagram below is a simplified representation of the relationship between the various combustion measurables, and how a change in one parameter affects the others.

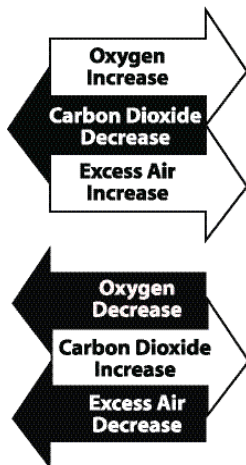

Courtesy of Erik Rasmussen ESCO Press 2007.

For Service

Call Fieldpiece Instruments for current costs on our fixed price warranty service. Send check or money order for the amount quoted. Send your digital manifold, freight prepaid, to Fieldpiece Instruments. Send proof of date and location of purchase for in-warranty service. The meter will be repaired or replaced, at the option of Fieldpiece, and returned via least cost transportation.

For international customers, warranty for products purchased outside of the U.S. should be handled through local distributors.

Fieldpiece
 Designed in USA
 MADE IN TAIWAN

www.fieldpiece.com

©Fieldpiece Instruments, Inc 2015; v16

More Instruments from Fieldpiece



Digital Refrigerant Manifolds



Wireless Measurements

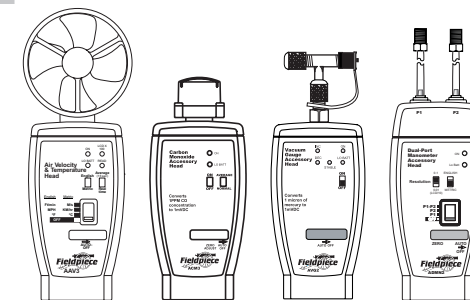

Accessory Heads

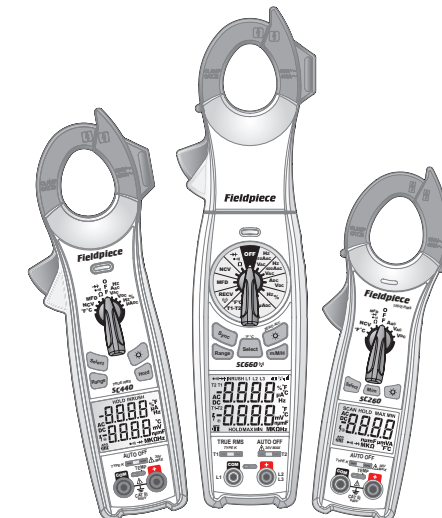

Clamp Meters